



# Tier1 Water Softener

## Everyday 165 Series



# INSTRUCTION MANUAL

Please read this manual in detail before using the system and keep it in a safe location for future reference.

# Contents

Important Notices .....	3
System Specifications.....	3
Operating Conditions.....	4
Installation Instructions .....	4
Prior to Installation: .....	4
Included Parts: .....	5
Additional Components: .....	5
Installation Diagram: (Front View).....	6
Installation Diagram: (Top View) .....	6
Step 1: Attaching the Control Valve.....	7
Step 2: Attaching the Bypass to the Control Valve .....	8
Step 3: Assembling the Brine Tank .....	10
Step 4: Connecting the Brine Tank to the Valve .....	12
Step 5: Connecting the Drain and Overflow tubing.....	13
Step 6: Connect the Water Softener to the Home’s Plumbing.....	14
Step 7: Initial System Startup.....	15
Step 8: System Programming.....	16
Calculating Capacity: .....	16
Control Valve Settings and Usage .....	17
How to Unlock the Buttons:.....	18
How to Perform a Manual Regeneration:.....	18
How to View/Edit Settings in the Programming Menu: .....	18
Control Valve Programming Settings .....	19
Troubleshooting.....	20
Warranty .....	21
US Water Filters Limited Product Warranty: .....	21
General Provisions: .....	22
Care and Maintenance.....	22
Support.....	22

# Important Notices

- Read this manual thoroughly to become familiar with the system and its capabilities before installation or operation. Failure to follow instructions in this manual could result in personal injury or property damage.
  - This system and its installation must comply with state and local regulations. Check with your local public works department for plumbing and sanitation codes. In the event the codes conflict with any content in this manual the local codes must be followed instead.
  - Consult a licensed professional for any plumbing or electrical work required prior to the installation of this system.
  - The system must be connected to a GFCI breaker or GFCI outlet.
  - Do not use an extension cord for permanent installation of the system.
  - This system is designed to operate on pressures of 20 psi to 87 psi. If the water pressure is higher than 80 psi a pressure reducing valve is required on the water supply line prior to the system.
  - This unit is capable of operating at temperatures between 40°F and 120°F (5°C - 50°C). Do not use this system on hot water supplies.
  - Do not install this unit where it may be exposed to wet weather, direct sunlight, or temperatures outside of the range specified above.
  - Avoid damaging, pinching, or leaking O-rings by applying food grade silicone lubricant to all seals during installation.
  - Do not use water that is microbiologically unsafe without adequate disinfection before or after this system.
  - The system drain line must have an air gap from the drain to avoid cross contamination if the sewer or septic tank backs up.
  - System parameters must be adjusted according to the working environment, water quality, and application of the system. Test water periodically to verify system performance.
  - If installed with a metal plumbing system a grounding jumper wire is needed to bridge over the plastic components of the system to ensure appliances downstream are properly grounded.
  - This publication is based on information available when approved for printing. Continuing design refinement could cause changes that may not be included in this publication.
- US Water filters Inc. reserves the right to change the specifications referred to in this literature at any time, without prior notice.

# System Specifications

Model	Capacity	Tank Size	Brine Tank Size	Resin Cu. Ft.	Flow Rate*	Backwash
165-124	24,000	8" x 35"	13.5" x 34"	0.75 cubic feet	18 gpm	4 gpm
165-132S	32,000	10" x 35"	13.5" x 34"	1 cubic feet	18 gpm	4 gpm
165-132	32,000	9" x 48"	13.5" x 34"	1 cubic feet	18 gpm	4 gpm
165-150	48,000	10" x 54"	13.5" x 34"	1.5 cubic feet	18 gpm	4 gpm
165-164	64,000	12" x 52"	13.5" x 34"	2 cubic feet	18 gpm	4 gpm

*\*At the stated service flow rates, the pressure drop through the systems will not exceed 15 psi.*

# Operating Conditions

Environmental Parameters	Air Temperature	40°F - 120°F
	Relative Humidity	Less than 95% @ 77°F
	Electrical Requirement	AC100~240V/50~60Hz GFCI
Water Quality Parameters	Water Pressure	20 psi - 87 psi
	Water Temperature	40°F - 120°F
	Free Chlorine	<0.1 mg/L
	Iron	< 0.3 mg/L
	Turbidity	< 5 NTU Down-Flow Regeneration < 20 NTU Filter Applications

## Installation Instructions

### Prior to Installation:

- Review the included parts list and make sure you have all of the included parts before installation.
- If you are installing in a location that has an electric water heater, shut off the power to the water heater and unplug it before beginning installation.
- Identify where you are going to install the water softener.
  - The softener should be installed on the main water supply before the water heater but after plumbing that supplies outdoor faucets. (if possible)
  - The softener should be installed on a level surface within 6 feet of an electrical outlet, and as close to a suitable drain as possible. (floor drain, laundry tub, standpipe, or sump)
  - If the softener is being installed outdoors it must be protected from the elements, and kept within the environment parameters of the system.
- Turn off the main water supply valve completely.
- Test that the water is completely shut off by opening the closest cold water faucet.  
(Note: DO NOT continue installing the water softener if the water supply cannot be turned off.)

**Included Parts:**

*This is a list of all the components included with the system. Double check that you are not missing any components before beginning the installation of the system.*

- 1) Resin tank
- 2) Riser tube
- 3) Lower distributor basket
- 4) Upper distributor basket
- 5) Control valve
- 6) Control valve O-ring
- 7) Bypass valve
- 8) Bypass adapters x2
- 9) Bypass adapter seals x2
- 10) 1" Elbow adapters x2
- 11) Locking clips x 4
- 12) Brine adapter nut
- 13) Brine tubing insert w/screen
- 14) Lubricant
- 15) Brine tubing
- 16) Drain tubing
- 17) Overflow elbow
- 18) Brine well bracket
- 19) Brine tank
- 20) Brine well
- 21) Float assembly
- 22) Salt shelf
- 23) Shelf legs

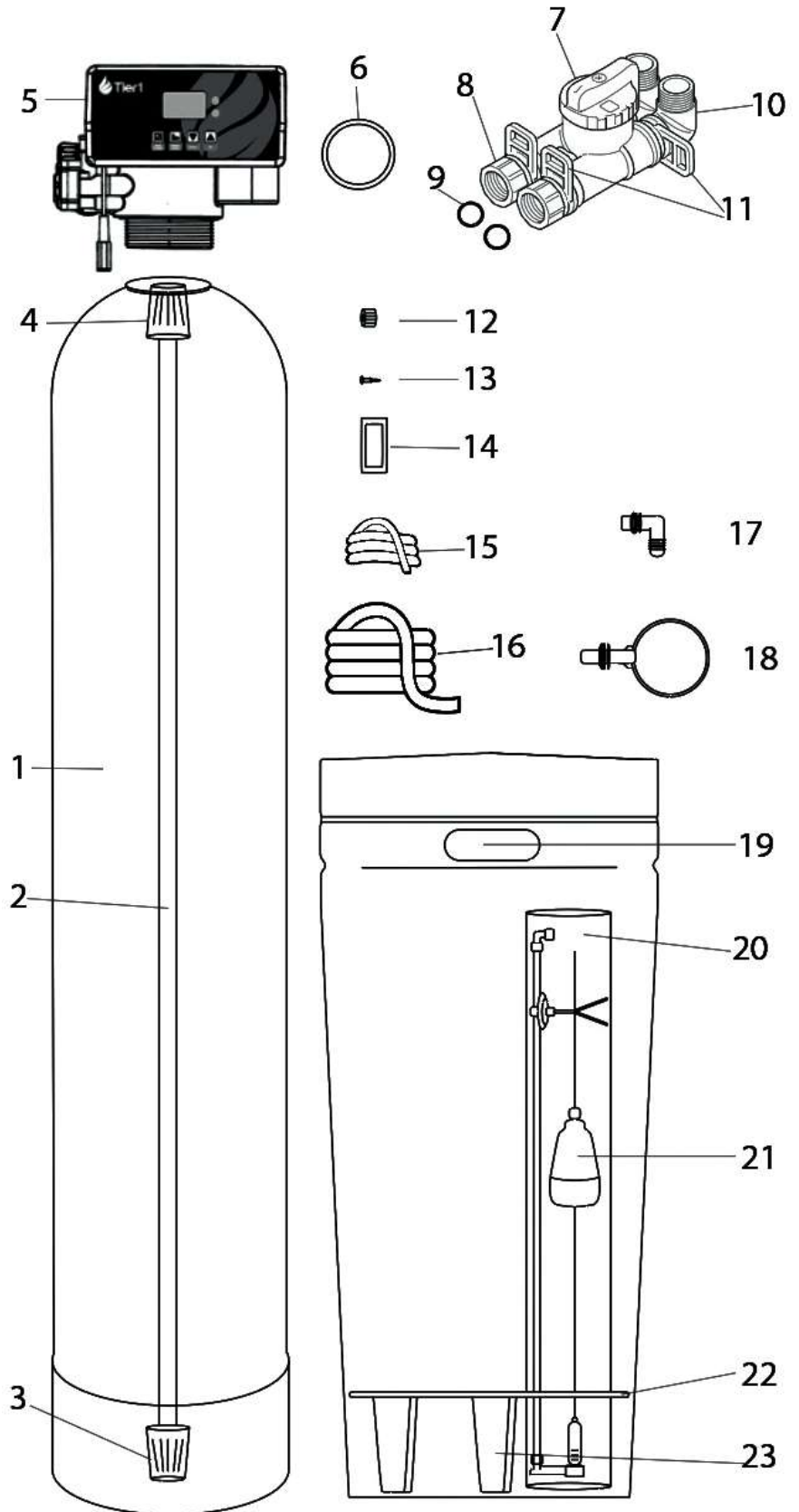

**Additional Components:**

*These tools and components are not included with the system but may be necessary for the installation of the system.*

- Pipe / Tubing cutter
- Pipe fittings / Flex connectors
- Teflon tape / Thread sealant
- Air gap connector for the drain
- Water softener salt

## Installation Diagram: (Front View)

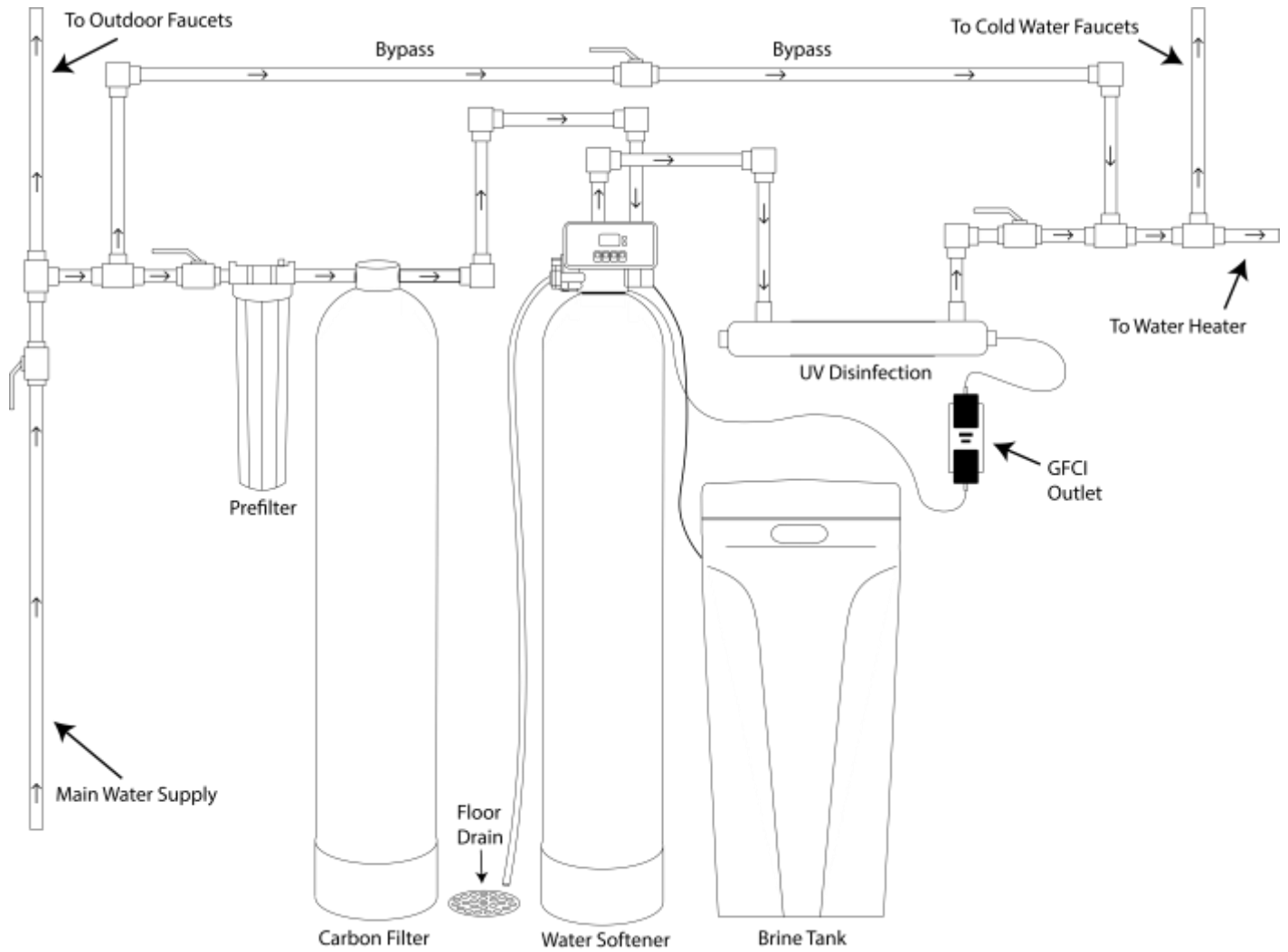

*The carbon filter and UV disinfection units are shown as examples when installing with other filtration systems.*

## Installation Diagram: (Top View)

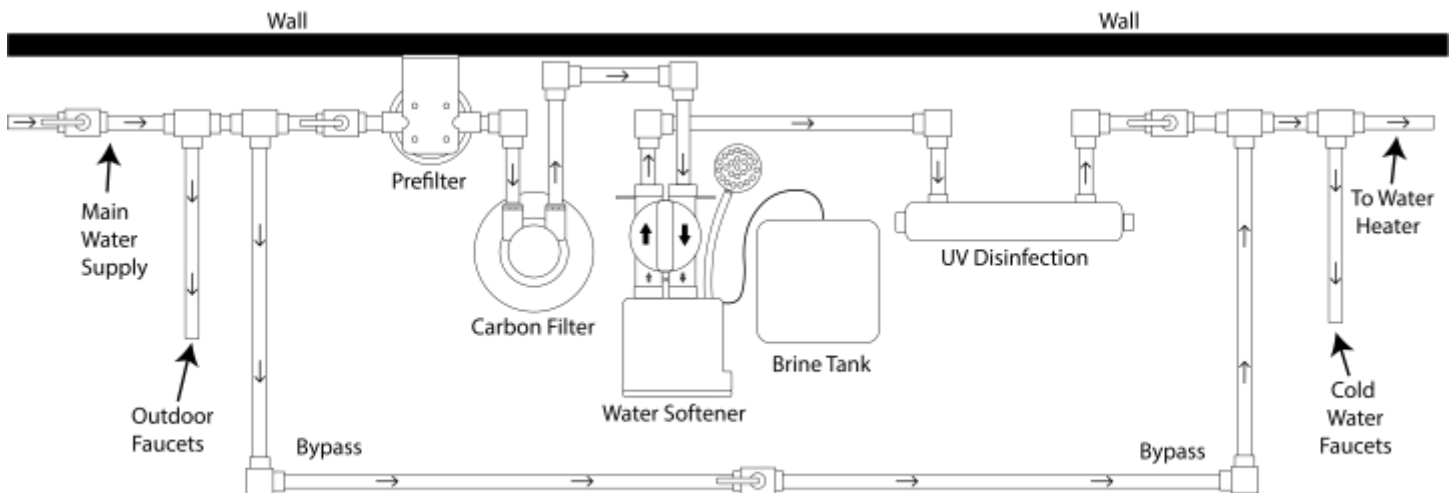

*The carbon filter and UV disinfection units are shown as examples when installing with other filtration systems.*

## Step 1: Attaching the Control Valve

You will need the Resin tank, Control valve, Control valve O-ring, Upper distributor basket, and Lubricant.

1. Apply a small amount of lubricant to your finger.
2. Apply lubricant to the riser tube O-ring inside the control valve.
3. Apply lubricant to the main valve O-ring.
4. Install the main O-ring on the valve.



1



2



3



4

5. Attach the upper distributor to the base of the control valve by twisting clockwise until it clicks and locks into place.

*(Note: Double check that the distributor basket locks securely to the control valve. If the basket is not locked resin will be able to escape the mineral tank during backwashing.)*



5

6. Slide the control valve and upper distributor over the riser tube and thread onto the resin tank until it is hand tight.



6

## Step 2: Attaching the Bypass to the Control Valve

You will need the Lubricant, Bypass valve, Bypass adapters (x2), Bypass adapter seals (x2), 1" Elbow adapters (x2), and Locking clips (x4).

7. Apply a small amount of lubricant to the two adapter seals, and the O-rings on the bypass and elbow adapters.
8. Insert the adapter seal into the bypass adapters.
9. Attach the bypass adapters to the valve.
10. The flow meter impeller comes installed in the bypass, check to make sure it is in place, or if it falls out, re-install it on the output side of the bypass.



7



8



9



10

11. Push the bypass valve onto the bypass adapters.

*(Note: It is important to push the bypass completely onto the adapters in order to install the locking clips. DO NOT force the locking clips.)*

If the bypass is not fully connected (**11a**), the locking clips will not install. Ensure the bypass is connected properly, (**11b**), before installing the locking clips.



11



11a (NOT fully connected)



11b (Connected Properly)



12. Locate two of the four black locking clips.
13. Insert the locking clips vertically by pushing them down into the holes on the bypass securing the connector.  
(Refer to step 11 if you feel you are having to force clips into place.)
14. Take the two 1" elbows adapters and connect them to the bypass.
15. Insert the remaining two locking clips horizontally by pushing them into the holes on the bypass securing the elbows.



12



13



14



15

*Note: If the elbow adapters are not fully connected (15a), DO NOT force the locking clips.*

*Ensure the elbows are fully connected (15b), before installing the locking clips.*



15a (NOT fully connected)



15b (Connected Properly)

16. Locate the end of the flow probe cord connected to the back of the control valve.
17. Insert the end of the flow probe into the semi-circular notch in the middle of the bypass.



16



17

### Step 3: Assembling the Brine Tank

You will need the Brine tank, Salt shelf, Shelf legs (x4), Brine well, Float assembly, Brine well bracket, Overflow elbow, and Brine tubing.

#### Salt Shelf

18. Line the holes in the top of a shelf leg with the clips around the holes in the bottom of the salt shelf and push them together until the leg clips into place.
19. Repeat 18 for the rest of the shelf legs until the salt shelf is completely assembled.
20. Place the assembled salt shelf into the brine tank oriented so that the large brine well hole is on the same side as the two holes in the top of the brine tank.



18



19



20

#### Brine Well

21. Insert the brine well into the hole in the salt shelf, and spin it so that the hole in the top of the brine well lines up with the holes in the top of the brine tank.
22. Remove the black nut from the brine well bracket.
23. Slide the bracket over the brine well with the threaded end sticking out through the upper hole of the brine tank and reattach the nut from the outside of the tank to hold the bracket in place.



21



22



23

## Overflow Elbow

24. Remove the black nut from the overflow elbow.
25. Slide the threaded end of the overflow elbow through the bottom hole in the brine tank and thread the nut back onto the overflow elbow from the inside of the brine tank securing it in place.



24



25

## Float Assembly & Brine Tubing



Straight Float Assembly



Twisted Float Assembly

*Before connecting the brine tubing ensure that the float assembly is not twisted as this will cause the float to not work properly. The two tubes of the float assembly must be straight and parallel or the float can get stuck causing the brine tank not to fill properly. (Be careful not to twist the float assembly while installing the brine tubing, and ensure the float assembly is still straight when you are done.)*

26. Remove the compression nut and bushing insert from the elbow at the top of the float assembly.



26

27. Insert the brine tubing through the upper hole in the brine tank. Once it has been pushed into the brine well, slide the tubing through the compression nut and insert the bushing into the end.

28. Push the tubing into the elbow as far as it will go, and tighten the nut to secure the tubing.



27



28

## Step 4: Connecting the Brine Tank to the Valve

You will need the Brine tubing, Brine tubing insert w/screen, Brine adapter nut, and the Control valve.

29. Insert the bushing with the screen to the open end of the brine tubing, and slide the other compression nut over the end of the tubing.



29

30. (Optional) To make connecting the brine tubing easier you may disconnect the locking clip from the brine tubing adapter on the control valve and disconnect the brine tubing adapter from the valve.



30

*Note: You can connect the brine tubing to the adapter without removing the adapter from the control valve.*

31. Insert the tubing into the brine adapter and tighten the locking nut to secure the tubing to the adapter.



31

32. Reconnect the brine adapter to the control valve.
33. Reinsert the brine locking clip to secure the brine adapter in place.



32



33

## Step 5: Connecting the Drain and Overflow tubing

You will need the Drain tubing, Control valve, and Tape measure (optional).

### Drain Tubing

34. Disconnect the drain adapter from the valve by unscrewing the drain swivel nut and pulling out the barbed fitting.
35. (Optional) To make connecting the drain tubing easier it is recommend to heat the end of the tubing with a hairdryer or a glass of water that has been microwaved for approximately 60 seconds.
36. Slide the swivel nut onto the drain tubing and insert the barbed fitting.
37. Reconnect the drain adapter to the valve by screwing the swivel nut back onto the threads of the drain outlet.



34



35



36



37

38. Measure the length of drain line tubing that is required to connect from the control valve to the nearest drain and cut the tubing to length.

**(WARNING: DO NOT connect the drain tubing to the brine tank. This will cause the brine tank to overflow with water during regeneration.)**



38



## Overflow Tubing (Optional)

If you have left over drain line tubing after connecting the softener to the drain you can use the extra tubing for the brine tank overflow, but additional tubing may be required.

39. Push tubing onto the overflow elbow and direct the tubing towards the nearest floor drain or a drip pan.

(Note: Water does not flow out of the overflow elbow under normal operation. The overflow is designed to direct water to a drain or drip pan only in the rare case that the float valve malfunctions.)



39

## Step 6: Connect the Water Softener to the Home's Plumbing

You will need additional plumbing components to connect your home's plumbing to the 1" elbow adapters.

1" Flex Connectors can be an easy to use option, but additional Copper, PEX, CPVC, or PVC fittings may be required depending on your home's specific plumbing.

40. Connect your water softener to your main water supply. The plumbing connections necessary to connect to your softener will depend on the size, material, and location of the plumbing in your home.

Note: However you connect the softener to your plumbing make sure that the water flows in the same direction as the arrows on the bypass.

The diagram below is an example multi-system installation, but your installation may look different depending on the location of your home's plumbing, drain, and space available.



40

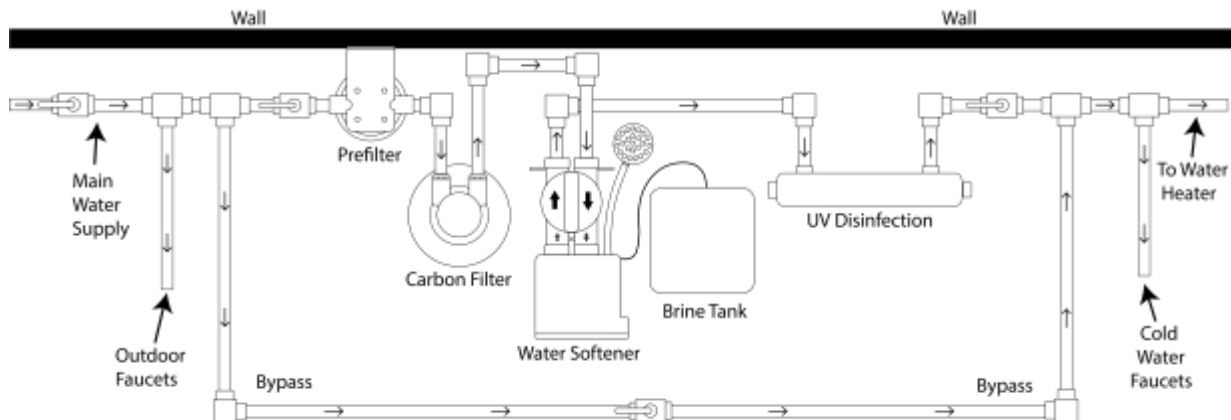

## Step 7: Initial System Startup

41. Put the water softener into the bypassed position.
42. Slowly open the main water supply and check the plumbing connections to the softeners for any leaks.



*If any leaks are present, close the main water supply and fix them before proceeding.*

43. Plug in the control valve. When first powered on the ceramic disk will spin for 60 seconds, and the screen will display (-00-).

A small rectangular digital display with a black background and white characters showing "-00-".



41

44. The system automatically locks after being idle for 60 seconds. To unlock the system press and hold the  and  buttons at the same time for 5 seconds.

45. With the system unlocked press the  button to initiate a regeneration.

*When the regeneration is started the screen will display (-00-). This screen is displayed anytime the motor is running and the ceramic disk valve is rotating to a new position.*

A small rectangular digital display with a black background and white characters showing "-00-".

46. Wait until the valve enters the Backwash stage of the regeneration and the screen displays: (2. - 05).

A small rectangular digital display with a black background and white characters showing "2. - 05".

47. Once the screen displays (2. - 05), slowly open the bypass valve on the softener to fill the resin tank with water.

**IMPORTANT:** When you open the bypass valve water will begin to run into the softener and out the drain line. **THIS WILL MAKE NOISE** and is normal and expected during a regeneration.

*Check the softener and drain line again for any leaks. If any are present put the softener back into bypass (picture 41) and correct them before proceeding.*

48. Add 1-2 bags of water softener salt to the brine tank, and allow the softener to run through the rest of the manual regeneration.















*(Note: You can continue with setting the system programming on the next page during the initial regeneration.)*



47

## Step 8: System Programming

Full list of programming settings can be found on page 18 of the manual. These steps cover the only settings that need to be changes from the factory default during the initial setup of the up the system.

49. The system automatically locks the buttons after being idle for 60 seconds. To unlock the buttons press and hold the  and  buttons at the same time for 5 seconds.
50. Unlock the screen and press the  button. The settings menu indicator will turn on, and the time of day setting will be displayed.
51. Press the  button and use the  and  buttons to set the hour (the system uses a 24 hour clock).
52. Press the  button again, and use the  and  buttons to set the minutes.
53. Press the  button one more time to save the time setting.
54. Press the  button 3 times to get to the capacity setting. (Default of 1750)
55. Press the  button and use the  and  buttons to adjust the capacity setting based on the size of your softener and your specific water quality using the calculation below.

### Calculating Capacity:

The total capacity of the softener will depend on which model you have. Refer to the system specifications if you are not sure of your systems total grain capacity (24k, 32k, 48k, 64k). You will also need to know the hardness of your water in grains per gallon (gpg), via a water test or local municipal water utility. If your water hardness is listed as parts per million (ppm) you can calculate the gpg by dividing the ppm by 17.1

( \_\_\_\_\_ ppm ÷ 17.1 = \_\_\_\_\_ gpg).

**Calculation: (Softener Capacity \_\_\_\_\_ ÷ Water Hardness \_\_\_\_\_) × 0.75 (Reserve Capacity)**

What is reserve capacity and why do I need it?

Reserve Capacity is a percentage of the water softeners total capacity that is kept in “reserve”. Because the system regenerates at a specific time of night sometimes the remaining capacity will hit zero in the middle of the day. The reserve capacity is a buffer to ensure you still have soft water until the softener can regenerate that night.

Here is an example calculation for a **48,000** grain water softener where the water has **400** ppm of hardness.

1. Calculate Grains per Gallon from PPM: ( 400 ppm ÷ 17.1 = 23.4 gpg ).

(Softener Capacity 48,000 ÷ Water Hardness 23.4 ) × 0.75 (Reserve Capacity) = **1538** gallon capacity

*Note: If the system is being used on well water and iron is present, add an additional 4 gpg of hardness to the calculation for every 1 ppm of iron.*

*(For iron levels above 0.3ppm we strongly recommend additional treatment for iron before the softener.)*



# Control Valve Settings and Usage

When the valve is in service the display will cycle through four screens:

1. Time of Day: When the time is displayed the center two dots on the display will be flashing, the valve uses a 24 clock so 00:00-11:59 is AM and 12:00 - 23:59 is PM.
2. Regeneration Time: When the valve is displaying the Regeneration time the center two dots on the display will be solid instead of flashing, the default setting is 02:00 or 2 am.
3. Remaining Capacity: When the valve displays the remaining number of gallons until the next regeneration the top indicator light will illuminate.
4. Current Flow Rate: When the valve displays the current flow rate through the valve the bottom indicator light will illuminate.



When the valve enters a regeneration and the motor is running the display will show “-00-” to indicate the valve is switching between stages.



The 5 different valve stages and their numerical display are as follows:

Service → Backwash → Brine & Slow Rinse → Fast Rinse → Brine Refill → Service.

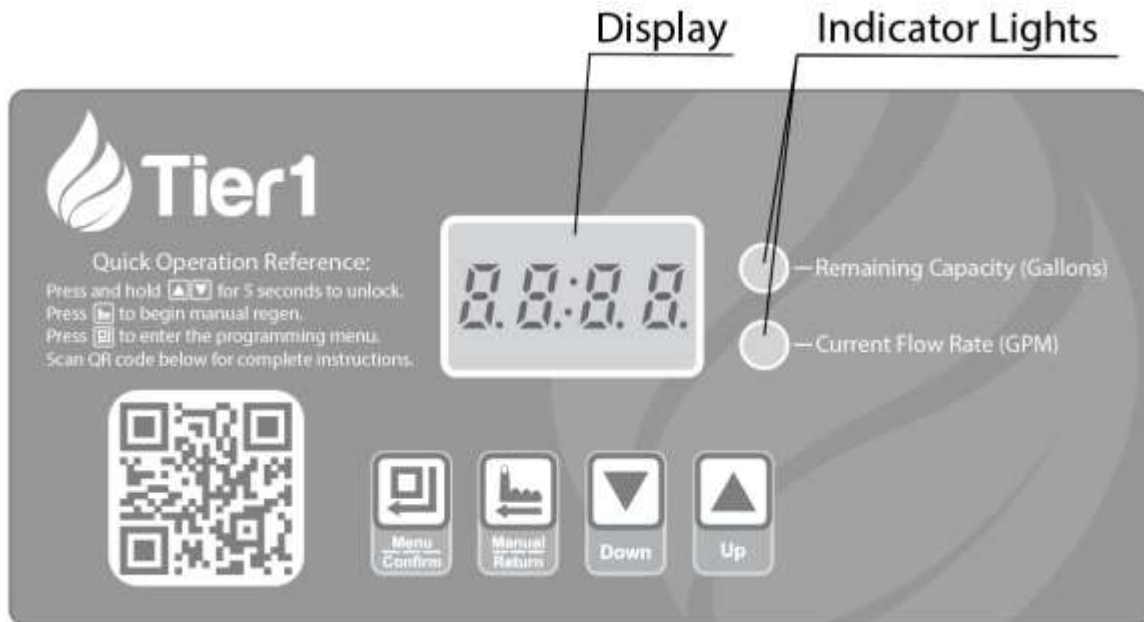
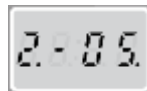

In addition to the dedicated indicator lights the system also uses the decimal points in the numerical display to indicate when the system's buttons are locked, and when the system is in the settings menu.

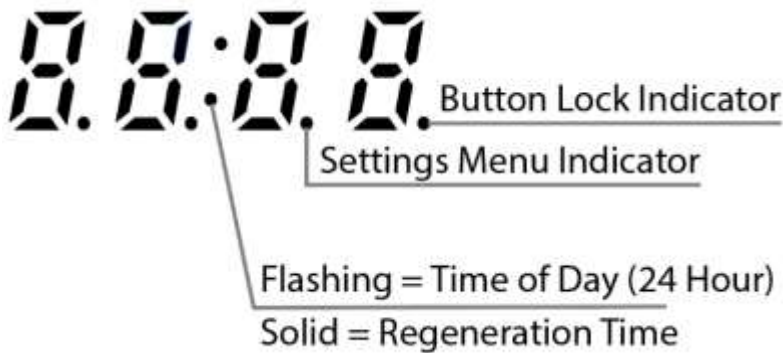



*The 4<sup>th</sup> decimal light indicates Button Lock, if this light is illuminated the buttons are locked and the system must be unlocked to operate.*



*The 3<sup>rd</sup> decimal light will illuminate when entering the Settings Menu.*

*The two center dots indicate Time of Day or Regeneration Time depending on if they are flashing or solid.*









### How to Unlock the Buttons:

The system automatically locks the buttons after being idle for 60 seconds. To unlock the buttons press and hold the  and  buttons at the same time for 5 seconds. After 5 seconds the system will beep and the button lock indicator will turn off.

### How to Perform a Manual Regeneration:

To initiate a manual regeneration unlock the screen and press the  button. The valve will display “-00-” and start turning to begin the regeneration. During a regeneration pressing the  button will immediately advance to the next stage of the regeneration.

### How to View/Edit Settings in the Programming Menu:

To view and change the programming settings unlock the screen and press the  button. The settings menu indicator decimal will turn on, and the time of day setting will be displayed. Use the  and  buttons to navigate through the settings. To change a setting navigate to the setting you want to change in the menu and press the  button. The value of the setting will start blinking, use the  and  buttons to adjust the value, and press the  button again to save the changes. When finished programming press the  button to exit the menu.

# Control Valve Programming Settings

Function	Indicator	Factory Default	Parameter Range	Notes
Time of Day	“.” Flashing	12:12	00:00 ~ 23:59	When “.” is flashing Time of Day is being displayed. When programming the hours and minutes set separately. Set the hours, press the  button, and set the minutes.
Regeneration Time	“.” Solid	02:00	00:00 ~ 23:59	When “.” is solid Regeneration Time is being displayed. This is time the system will regenerate when set to Meter Delayed. Set to a time with water use is minimal.
Control Mode	A -	A-01	A-01	Meter Delayed: When the remaining treatment capacity reaches zero (0) the system will wait until the set regeneration time before regenerating.
			A-02	Meter Immediate: When the remaining treatment capacity reaches zero (0) the system will immediately begin regenerating.
Water Treatment Capacity	Remaining Capacity Light	1750	0 ~ 9999	Number of gallons that will be treated before the system regenerates. Optimal setting will depend on the type and size of system, along with inlet water quality.
Backwash Time	2.-	2.- 05	0 ~ 99	Length of the backwash stage of regeneration in minutes.
Brine & Slow Rinse Time	3.-	3.- 60	0 ~ 99	Length of the Brine & Slow Rinse stage of regeneration in minutes.
Fast Rinse Time	4.-	4.- 05	0 ~ 99	Length of the Fast Rinse of regeneration in minutes.
Brine Refill Time	5.-	5.- 05	0 ~ 99	Length of the Brine Refill stage of regeneration in minutes.
Max Regeneration Interval	H -	H - 30	0 ~ 40	This is the maximum number of days between regenerations, at this number of days the system will regenerate regardless of the remaining treatment capacity.
Signal Output Mode	b -	b - 01	b - 01	Signal on at the start of the regeneration and off at the end.
			b - 02	Signal on between each stage of regeneration, and off during each stage.

# Troubleshooting

Problem	Cause	Correction
1). No soft water and salt level is not dropping.	<p>A). Flow probe is not placed correctly.</p> <p>B). Salt Bridge has formed in the brine tank.</p> <p>C). System is plumbed incorrectly, inlet and outlet are swapped.</p> <p>D). Bypass valve is in bypass position.</p> <p>E). Impeller is not registering flow.</p>	<p>A). Insert flow probe into dock on bypass valve.</p> <p>B). Break up salt in brine tank, perform manual regeneration on the system.</p> <p>C). Verify the flow of water into the system matches the arrows on the bypass. If they do not, swap the inlet/outlet.</p> <p>D). Move bypass valve into the service position.</p> <p>E). Verify impeller is properly placed in the bypass. Cleaning the impeller with vinegar and water may be necessary after extended use or if hard water passes through it.</p>
2). System regenerates at the incorrect time.	<p>A). Time of day improperly set.</p>	<p>A). Reset time of day.</p>
3). Complete loss of water pressure when system is in service.	<p>A). Resin has become fouled due to incoming water quality.</p>	<p>A). For high chlorine and iron content on incoming water, pre-treat to prevent this. Place system in bypass to verify the softener is the source of the pressure loss. Replace resin tank.</p>
4). Excessive water in the brine tank.	<p>A). Leak at brine line connection in the brine tank well.</p> <p>B). Salt bridge has formed in the brine tank.</p> <p>C). Drain Line is blocked</p>	<p>A). Place system into the 3<sup>rd</sup> stage of the regeneration, check for leaks at the elbow connection and verify water level is dropping. If a leak is detected, re-insert the line firmly.</p> <p>B). Break up salt in brine tank, perform manual regeneration on the system.</p> <p>C). Verify there is no kinks in the drain line or blockage within the drain line.</p>
5). Resin in household plumbing.	<p>A). Failure of the distributor basket or the riser tube.</p>	<p>A). Can occur with highly chlorinated incoming water, pre-treat to prevent this. Bypass softener, flush waterlines, replace resin tank.</p>
6). Water hard some of the time.	<p>A). Incorrect water treatment capacity set.</p> <p>B). Excessive hot water being used while system is regenerating.</p> <p>C). Increase in incoming water hardness.</p> <p>D). Plumbing leak in household plumbing system.</p>	<p>A). Increase water treatment capacity.</p> <p>B). Change regeneration time to when water service will be sparse, avoid using hot water when the system regenerates as it can bring hard water to the water heater.</p> <p>C). Test incoming water for hardness, adjust water treatment capacity, utilize resin cleanser.</p> <p>D). Small leaks can cause over-regeneration of the system and loss of salt in the brine tank.</p>
7). E1, E3, or E4 error code.	<p>A). Damage to the Control Valve.</p>	<p>A). Replace control valve.</p>

# Warranty

## ***Extend your Warranty YOUR WARRANTY by using TIER1-WS-CLNSR-16 Water Softener Cleaner!***

The manufacturer warranty for your water softener is shown below. The one (1) year limited warranty period can be extended up to five (5) years if you use Tier1® TIER1-WS-CLNSR-16 Water Softener Cleaner on your system and register your system with US Water Filters at [tier1water.com/warranty-registration](http://tier1water.com/warranty-registration). Use one bottle of TIER1-WS-CLNSR-16 as directed every three (3) months from the date of purchase of the water softener. Proof of purchase of at least four (4) TIER1-WS-CLNSR-16 per twelve (12) month period is required for compliance with this warranty extension. Use of any water softener additive other than TIER1-WS-CLNSR-16 will not provide extended warranty coverage.

### **US Water Filters Limited Product Warranty:**

US Water Filters warrants to the end user that its Tier1 Everyday Series Water Softener will be free from defects in material and workmanship under normal use and service, and agrees to replace, at its discretion, any defective product within the warranty time periods from the date of purchase as specified below. The only exception shall be when proof of purchase or installation is provided and then the warranty period shall be from the date thereof. Labor necessary to maintain the product is not covered by the product warranty.

#### **One (1) Year Limited Warranty**

- US Water Filters will replace any part of the control valve, bypass, fittings or electronic components found in reasonable judgment to be defective in material or workmanship under normal use and service for (1) year after the date of purchase.

#### **Extended Limited Warranty**

- Register your system at <https://www.discountfilterstore.com/warranty-registration> or scan the QR code on page 22.
- Purchase and use of four (4) bottles of TIER1-WS-CLNSR-16 Water Softener Cleaner within one (1) year from the date of purchase of the system extends the warranty for an additional one (1) year.
- This may be repeated each year of ownership to continue extending the warranty up to a max of five (5) years from the date of purchase.

#### **Ten (10) Year limited Warranty**

- US Water Filters will provide a replacement fiberglass resin tank or brine tank that fails under normal use and service provided that the softener is at all times operated in accordance with the operating conditions specified in the manual.

## General Provisions:

No warranty is made, and is explicitly excluded, with respect to defects or damages due to neglect, misuse, alterations, accident, physical damage, misapplication, improper maintenance, installation outside operating specifications, or damage caused by acts of God, earthquakes, hurricanes, tornados, fire, floods, freezing, or other environmental damages.

These warranties do not cover normal wear and tear components like replacement filter cartridges, O-rings, seals, or filter media. Water Softener resin is considered a wear and tear component and can degrade quickly when exposed to iron, manganese, chlorine, or chloramines above the system water quality operating parameters. Pre-treatment is required for these contaminants if they are present to prevent premature fouling of the water softener resin.

THE WARRANTIES US WATER FILTERS GIVES IN THE ABOVE PARAGRAPHS ARE EXCLUSIVE, US WATER FILTERS DISCLAIMS ALL OTHER WARRANTIES, EXPRESS, IMPLIED OR STATUTORY AND SPECIFICALLY DISCLAIMS ANY IMPLIED WARRANTIES OF MERCHANTABILITY, FITNESS FOR A PARTICULAR PURPOSE OR IMPLIED WARRANTY OF WORKMANLIKE PERFORMANCE.

These warranties are governed by the laws of the state of Minnesota and may change at any time without notice. Some states do not allow limitations on how long an implied warranty lasts or exclusions or limitations of incidental or consequential damage, so the limitations and exclusions in this warranty may not apply to you. This warranty gives you specific legal rights, and you may have other rights which vary from state to state.

## Care and Maintenance

Use **TIER1-WS-CLNSR-16** resin cleaner every 3 months to extend the life of your water softener and to keep the water softener is operating at full capacity.

Change the **TIER1-P20-20** prefilter every 6 months or as needed to prevent debris from getting into the system. *If sediment or debris get into the system the brine and injector screens could clog and require cleaning.*

Ensure the softener does not run out of salt. The brine tank can hold a maximum of 80lbs of salt, but we recommend only using a single bag at a time to avoid salt bridging and to make it easier to monitor the system.

## Support

For FAQs, Instructional Videos, Registering your System Warranty, Ordering Resin Cleaner, Prefilters, or other Replacement Parts, Scan the QR code located here, on the front of your System, or visit [www.discountfilterstore.com/water-softener-resources](http://www.discountfilterstore.com/water-softener-resources)

If you need additional assistance our contact our Technical Support Team located in Zumbrota, MN

Email: [support@tier1water.com](mailto:support@tier1water.com)

Phone: 1-855-378-9116

Hours: Monday – Friday, 8:00am-5:00pm (CST)

